

Digital Radiography System For Veterinary Hospital

VXR - 6M/9M



SIMPLE & EASY OPERATION !!

EXCELLENT IMAGE QUALITY!!

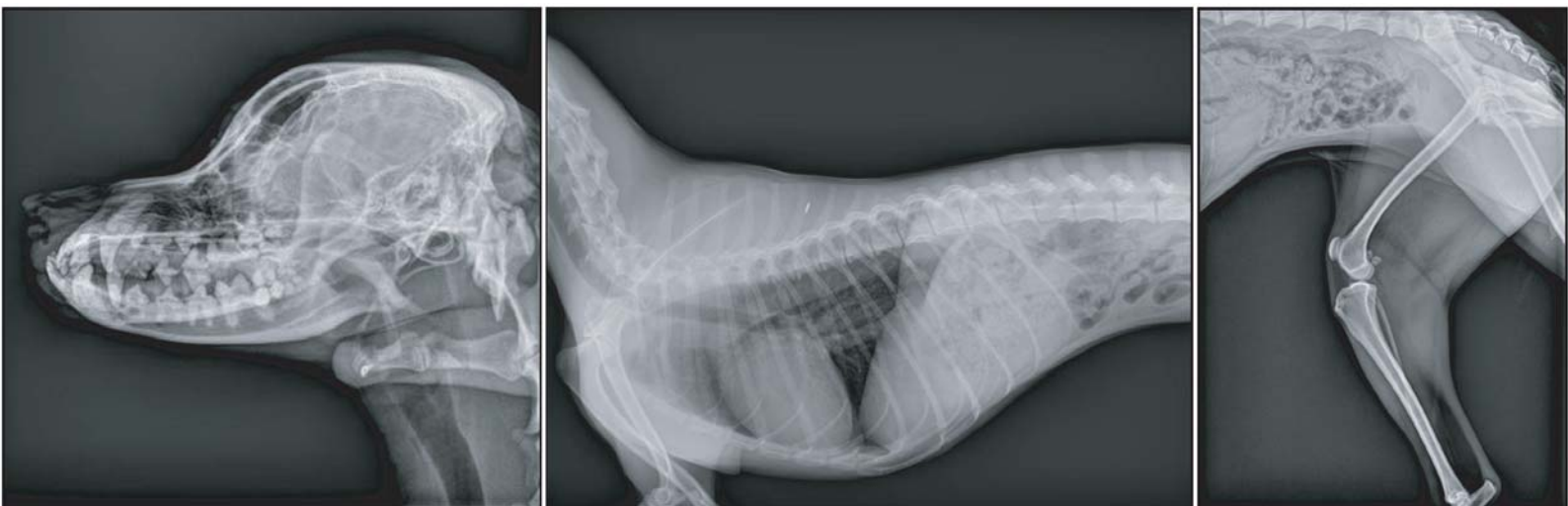

Veterinary Digital X-Ray System



Introduction

In recent veterinary practice, Digital Radiography (DR) is rapidly becoming the new standard to replace the traditional film-based x-ray technology.

VXR is a Digital Radiography system based on single CCD detector for Veterinary Hospital use.

VXR is designed to provide customers with the high performance DR equipment at affordable price.

VXR uses a very stable detector compared to CR and Flat panel detectors. Furthermore VXR provides high quality images for all diagnostic purposes.

The wide dynamic range of the detector allows the user to adjust the brightness and contrast in the image effectively. Consequently much more diagnostic information from the image can be obtained. The image software, MAXVue or QXvue, in VXR has been widely used in the veterinary DR systems already and has an excellent reputation in the market.

The x-ray generator base and table are designed to enable easy washing of the room floor on which the system is installed.

Considering the generally inadequate input power at most of the veterinary clinics, the x-ray generator is designed to output at high ratings and long exposure times which makes it possible to obtain an excellent image even for large animals.

With the remote diagnostic function of the x-ray generator, customer service can be provided quickly wherever the VXR is installed.

Features

- CCD Detector.
 - One CCD with specially dedicated optics for high spatial resolution.
 - Excellent dynamic range with 16-bit digitization.
 - High throughput radiography examination.
 - Very stable operation and long term life time.
- Most suitable software.
 - Comprehensive image processing by optimal tissue equalization, image sharpen and adjustment of brightness.
 - Image process parameters are selectable to maximize the preset algorithms.
 - Full size image display within 10 seconds.
 - DICOM 3.0 standard compliance.
 - Preview function.
 - Easy to learn and use.
- Superior High-Frequency X-ray Generator.
 - Superior performance.
 - Accuracy : $kV < \pm(1\%+1kV)$, $mA < \pm(3\%+1mA)$, $time < \pm(1\%+0.5ms)$
 - Reproducibility(Coefficient of Variation)
: $kV < 0.005$, $time < 0.005$, $mAs < 0.01$
 - Linearity (Coefficient of Linearity) : $CL < 0.01$
 - Real-time monitoring self diagnosis and error code display.
 - Tube anode HU display & protection, overload & housing overheat protection.
- Customer service.
 - Remote diagnosis via internet connection.
 - Quick response for customer's call.

SPECIFICATIONS

X-ray Generator

▪ Output Rating	:	32 kW	40 kW
▪ kVp Range	:	40 to 125	40 to 125
▪ Time Range	:	0.001 to 10 sec	0.001 to 10 sec
▪ mA Range	:	10 to 400mA	10 to 500mA
▪ Line Normal	:	230VAC/60Hz/1Φ	230VAC/60Hz/1Φ



X-ray Tube Assembly

▪ Model / Maker	:	E7242X / Toshiba
▪ Focal Spot Size	:	0.6 / 1.5 mm
▪ Max. Tube Voltage	:	125kV
▪ Max. Anode HU	:	140kJ(200kHU)

X-ray Collimator

▪ Control	:	Manual, 30 sec. timer
▪ Field Shape	:	Rectangular
▪ Max. Field Size	:	> 43x43cm / 100cm SID
▪ Max. kV Shield	:	150 kV
▪ Lamp	:	> 160 Lux



Tube Stand & Table

▪ SID	:	fixed 1,000 mm (40 inch)
▪ Table Top Size	:	1,400x700 mm (55.1x27.6 inch)
▪ Tabletop Movement	:	4-way
- Tabletop Stroke (Longitudinal)	:	250(±125)mm (9.84(±4.92) inch)
- Tabletop Stroke (Lateral)	:	200(±100)mm (7.87(±3.94) inch)
▪ Dimension	:	1,872(H)x1,400(W)x895(D) mm (73.7(H)x55.1(W)x35.2 inch)
▪ Weight	:	180kg (397lb)

Digital Image Receptor

	6M	9M
▪ Active Image Size	: 14"X17" (35 x 43 cm)	17"X17" (43 x 43 cm)
▪ Image Matrix	: 6 Mega Pixels (active : 2,048 X 2,478)	9 Mega Pixels (active : 3,072 X 3,072)
▪ Image Resolution	: 3.1 lp/mm	3.5 lp/mm
▪ Grid	: 180 lpi	200 lpi
▪ Dynamic Range	: 16-bit grayscale	16-bit grayscale

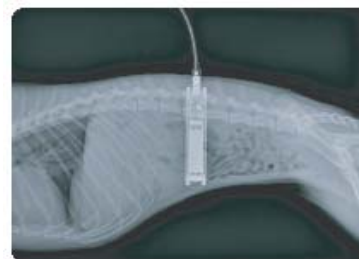

Imaging Workstation

▪ Intel(R) Pentium(R) Dual-Core processor	:	
▪ Memory	:	1GB DDR2 SDRAM
▪ OS	:	Windows(R) XP Professional
▪ Graphic	:	256MB ATI Radeon X1300 PCI
▪ HDD	:	SATA2 7200RPM Primary 80GB (for OS) Secondary 250GB (for Image storage)
▪ Monitor	:	20" UltraSharp Flat Panel LCD
▪ Optional Dual monitor display	:	

SOFTWARE

MAXXvue (VXR-6M) / QXvue (VXR-9M)

- Microsoft windows based interface.
- Image process parameters are selectable to maximize the preset algorithms.
- DICOM 3.0 standard compliance.
- Full resolution image within 10 seconds.
- A variety of post image processing including tissue equalization, sharpening, auto-crop and window leveling.
- Delivers improved outcomes for veterinary institutions.
- Preview function and Denoise, Lookup, Gamma, ROI

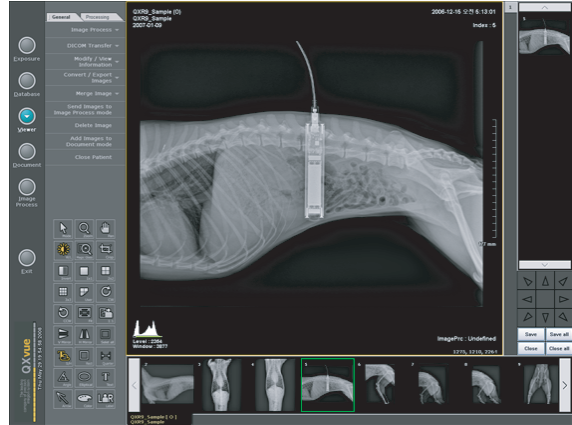

DIMENSION

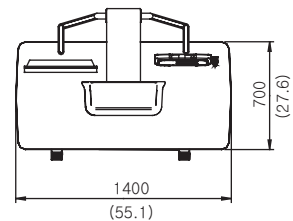
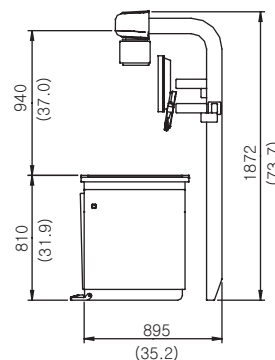
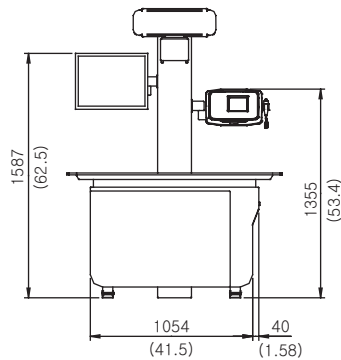
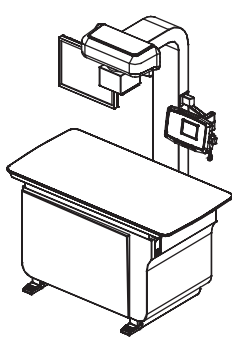

Unit: mm (inch)

FDA Clearance

FOR YOUR BEST CHOICE !!

DRGEM Corporation

7th Fl. Dongil Techno-town 1st, 826 Guro-dong,
Guro-gu, Seoul, Republic of Korea, 152-050

TEL: +82-2-869-8566

FAX: +82-2-869-8567

E-mail : drgem@drgem.co.kr

www.drgem.co.kr